

Modulo cablato integrato a scomparsa I Built-in power/data module



DATI COMMERCIALI | COMMERCIAL DATA

| | | |
|---------------------------------|--------|--|
| Codice prodotto Product code | 060.11 | Codice famiglia di prodotto - Valido per tutte le configurazioni Family product code - Valid for all configurations |
|---------------------------------|--------|--|

DATI TECNICI | TECHNICAL DATA

GENERALE | GENERAL



| | |
|---|-----------------------|
| Tensione nominale Rated voltage | 110 - 250 V ac, 50 Hz |
| Corrente nominale Rated current | 10 - 16A |
| Grado di protezione Degree of protection | IP20 |
| Ambiente di utilizzo Operating environment | Interno Indoor |

MATERIALI | MATERIALS

| | |
|--|--|
| Corpo Body | Alluminio Aluminium |
| Componenti assemblaggio Rated current | Tecnopolimero autoestinguente Flame retardant polymer |
| Prese elettriche Electric Sockets | Tecnopolimero autoestinguente Flame retardant polymer |

PRESE ELETTRICHE | ELECTRIC SOCKETS

B - E - F - G - I - J - K - L - Univ, Unel, 2P+T, con otturatori (protezione bimbi)
B - E - F - G - I - J - K - L - Univ Unel, 2P+T, with shutters (child protection)

| | | | |
|----------------------------|--|---------------------------|-------------------------------|
| Tipo Type |  | | |
| |  | | |
| Voltaggio Rated voltage | 220 - 250 V ac, 50 Hz | Preso tipo Socket type | E - F - G - P30 - UNEL - UNIV |
| | 110 - 125 V ac, 60 Hz | Preso tipo Socket type | B - UNIV |
| Corrente Rated current | 16 A | Preso tipo Socket type | E - F - K - L - P30 - UNEL |
| | 15 A | Preso tipo Socket type | B |
| | 13 A | Preso tipo Socket type | G |
| | 10 A | Preso tipo Socket type | I - J - UNIV |
| | Carico massimo complessivo Max.load power | 3400W | Preso tipo Socket type |
| | 2800W | Preso tipo Socket type | G |
| | 2200W | Preso tipo Socket type | I - J - UNIV |
| | 1200W | Preso tipo Socket type | B |



PORTE USB DA RICARICA | USB CHARGING PORT

| | | |
|--------------------------------|---|---|
| Ingresso Input | 100 - 250 Vac 50/60 Hz | |
| Uscita Output | USB A+A | 5V, 2.1A, P.Max. 10,5W (ricarica normale / condivisa tra le porte USB-A / standard charging shared between USB-A ports) |
| | USB A+C | USB C: 5V 3A, 9V 2A, 12V 1.5A max 18W (ricarica rapida / fast charging) USB A: 5V 3A, 9V 2A, 12V 1.5A max 18W (ricarica rapida / fast charging) USB A+ USB C: 5V 3A (1.5+1.5) P.Max. 15W (ricarica normale / standard charging) |
| | USB C | 5V3A, 9V2A, 12V1.5A max 18W (ricarica rapida / fast charging) |
| Compatibilità Compatibility | Tutti smartphone, tablet e altri dispositivi ricaricabili (fotocamere, auricolari, ecc.) All smartphones, tablets and other USB chargeable devices (cameras, headset etc.) | |

CONNETTORI DATI-VOCE | DATA-VOICE CONNECTORS

| | |
|---------------|--|
| LAN/Ethernet | RJ45 CAT.6 UTP / RJ45 CAT.6A STP RJ45 CAT.6 UTP / RJ45 CAT.6A STP |
| USB | USB 3.0 USB 3.0 |
| Video | VGA (15-pin) VGA (15-pin) |
| Audio | Mini-jack 3.5 mm Mini-jack 3.5 mm |
| Video - Audio | HDMI Display Port |

FINITURE | FINISHES

| | |
|---|--|
|  | Bianco ral 9010 opaco White ral 9010 matt |
|  | Nero ral 9004 opaco Black ral 9004 matt |
|  | Alluminio anodizzato Anodized Aluminium |

CERTIFICAZIONI | APPROVALS



NOTE | NOTES

- Personalizzabile per tipo di prese e connettori data
- Disponibili a richiesta altre finiture
- Uso solo in ambienti interni

ATTENZIONE!!!

- Questo apparecchio deve essere collegato a terra
- L'apparecchio deve essere collegato ad una presa principale correttamente installata e provvista di collegamento a terra in accordo alle norme vigenti.
- Se il prodotto viene montato in zone a rischio di contatto con l'acqua, bisogna applicare del silicone o sigillanti similari sul piano dove appoggia la cornice.

- It can be customized according to the type of sockets and data connectors
- Indoor use only
- Other finishes available upon request

WARNING!!!

- This appliance must be earthed
- This appliance must be connected to a main socket correctly installed and provided with ground connection in accordance with current norms.
- If the product is mounted in areas at risk of contact with water, it is necessary to apply silicone or similar sealants on the panel where the frame stands.



RAEE - Rifiuti derivanti da Apparecchiature Elettriche ed Elettroniche. Questi prodotti devono essere riciclati in modo adeguato e non devono essere gettati fra i rifiuti domestici o nei rifiuti municipali indifferenziati.

WEEE - Waste of electric and electronic equipment. These products must be recycled properly and should not be disposed as household waste. Disposal in general household waste is prohibited.

Tutte le dimensioni indicate sono nominali. I disegni e le immagini sono solo a scopo illustrativo. I dettagli del prodotto e le dimensioni sono soggetti a modifiche senza preavviso.

All dimensions quoted are nominal only. Drawings and images are for illustrative purposes only. All product dimensions and specifications are subject to change without notice.

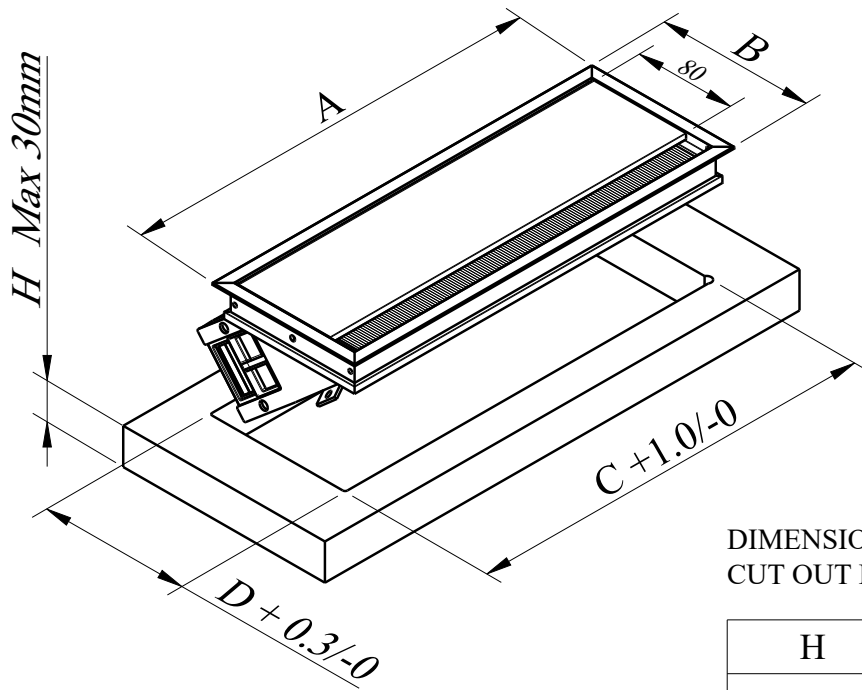

DIMENSIONI TAGLIO DI PIANO (mm)
CUT OUT DIMENSIONS (mm)

| H | A | B | C | D |
|-----------|-----|-----|-----|-----|
| 5 ↔ 25 | 240 | 120 | 231 | 112 |
| 5 ↔ 25 | 320 | 120 | 311 | 112 |
| 5 ↔ 25 | 454 | 120 | 445 | 112 |
| 25.1 ↔ 30 | 240 | 120 | 231 | 114 |
| 25.1 ↔ 30 | 320 | 120 | 311 | 114 |
| 25.1 ↔ 30 | 454 | 120 | 445 | 114 |

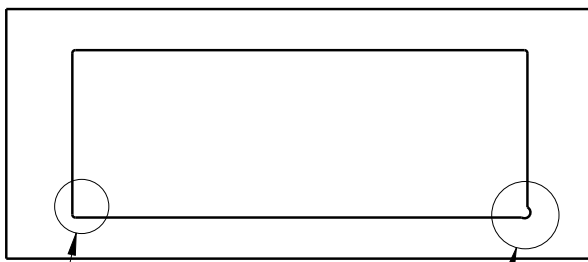

OPZIONE / OPTION A

OPZIONE / OPTION B

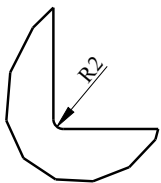

OPZIONE / OPTION A

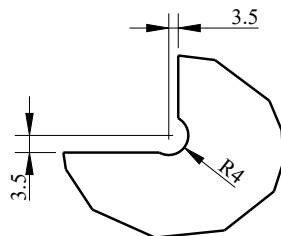

OPZIONE / OPTION B



PIANO / TOP MAX 25 mm
D= 112 mm

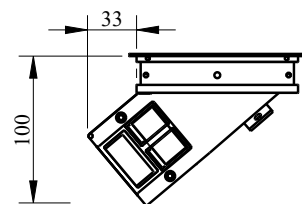
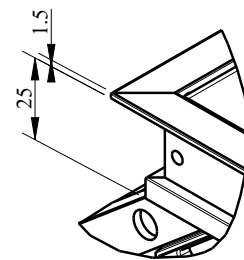





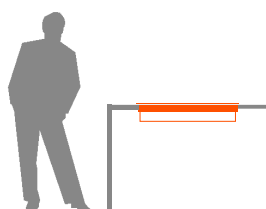
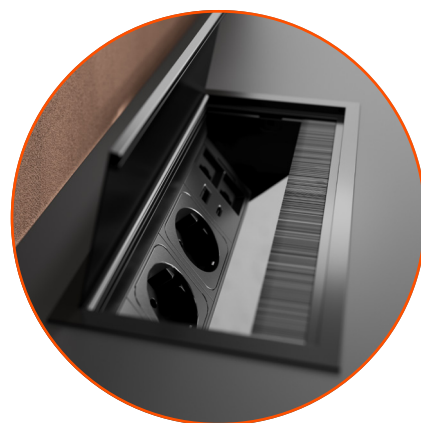
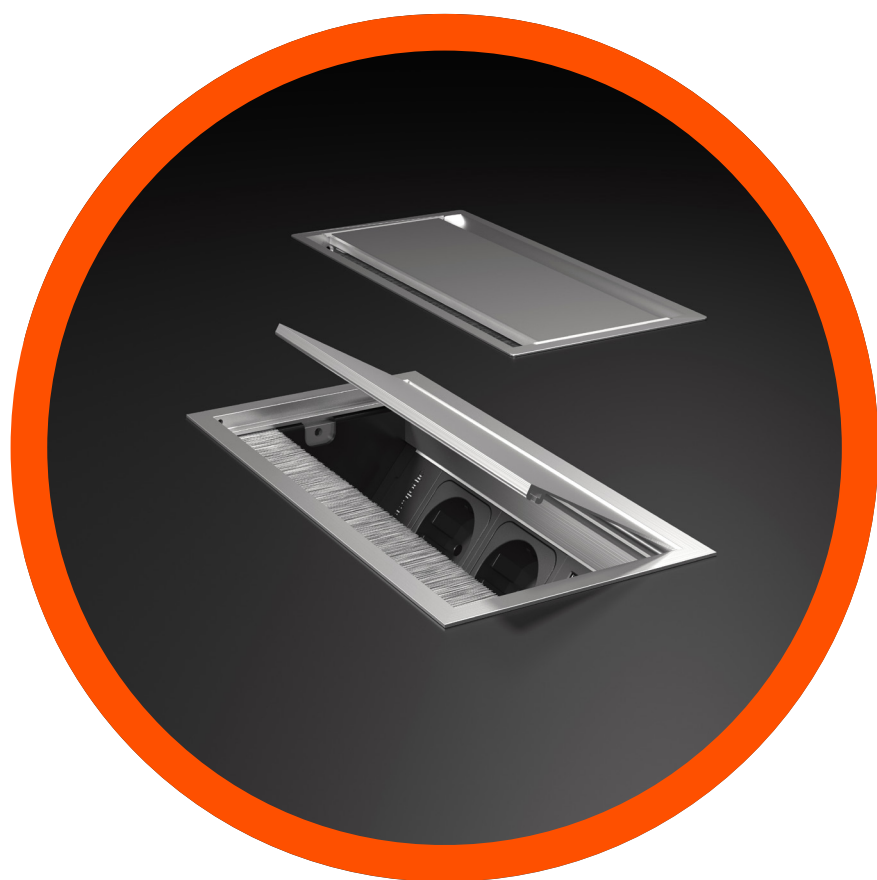







Dimensioni d'ingombro sotto piano (mm)
Overall dimension under the top (mm)

modulo a scomparsa
built-in module

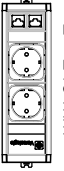
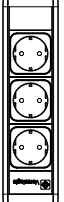
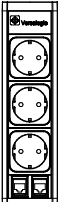
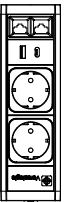

VERSAFLAP

| | | | | | | |
|--------------------------------------|---|--|---|--|---|---|
| PRESA SOCKET | |   U (JUNEL) |   F (SCHUKO) |   E (FRENCH) |   G (UK) | |
| L240 mm | | 2 FRUTTI POWER + 2 RJ45 GST IN/OUT 2 POWER SOCKETS + 2 RJ45 GST IN/OUT | | | | |
| CODICE CODE | alluminio anodizzato anodized aluminum | 060.11U.00001 | 060.11F.00001 | 060.11E.00001 | 060.11G.00001 |  L = 240 mm |
| | PREZZO PRICE | | | | | |
| | bianco white | 060.11U.00002 | 060.11F.00002 | 060.11E.00174 | 060.11G.00002 | |
| | PREZZO PRICE | | | | | |
| | nero black | 060.11U.00049 | 060.11F.00082 | 060.11E.00175 | 060.11G.00048 | |
| | | 3 FRUTTI POWER 3 POWER SOCKETS | | | | |
| CODICE CODE | alluminio anodizzato anodized aluminum | 060.11U.00003 | 060.11F.00003 | 060.11E.00167 | 060.11G.00003 |  L = 240 mm |
| | PREZZO PRICE | | | | | |
| | bianco white | 060.11U.00004 | 060.11F.00004 | 060.11E.00168 | 060.11G.00004 | |
| | PREZZO PRICE | | | | | |
| | nero black | 060.11U.00198 | 060.11F.00083 | 060.11E.00136 | 060.11G.00050 | |
| | | 3 FRUTTI POWER + 2 RJ45 3 POWER SOCKETS + 2 RJ45 | | | | |
| CODICE CODE | alluminio anodizzato anodized aluminum | 060.11U.00199 | 060.11F.00005 | 060.11E.00005 | 060.11G.00005 |  L = 240 mm |
| | PREZZO PRICE | | | | | |
| | bianco white | 060.11U.00200 | 060.11F.00006 | 060.11E.00006 | 060.11G.00006 | |
| | PREZZO PRICE | | | | | |
| | nero black | 060.11U.00201 | 060.11F.00084 | 060.11E.00137 | 060.11G.00051 | |
| | | 2 FRUTTI POWER + 2 RJ45 + 1 USB 5V (2 PORTE A+C) 2 POWER SOCKETS + 2 RJ45 + 1 USB 5V (2 PORTS A+C) | | | | |
| CODICE CODE | alluminio anodizzato anodized aluminum | 060.11U.00203 | 060.11F.00091 | 060.11E.00176 | 060.11G.00055 |  L = 240 mm |
| | PREZZO PRICE | | | | | |
| | bianco white | 060.11U.00204 | 060.11F.00092 | 060.11E.00173 | 060.11G.00056 | |
| | PREZZO PRICE | | | | | |
| | nero black | 060.11U.00205 | 060.11F.00093 | 060.11E.00177 | 060.11G.00057 | |
| NOTE NOTES | | | | | | |
| DIM. L x H x W 350 x 295 x 426 mm | |  | MOQ 4 PZ / PCS | | CODICE DOGANALE CUSTOM CODE 85366990 | |
| CAVI ESCLUSI CABLES NOT INCLUDED | |   | TUTTI I CAVI SONO DISPONIBILI NELLA SEZIONE CAVI DEL LISTINO, PAG. 112 ALL CABLES ARE LISTED IN THE PRICE LIST CABLE'S SECTION, PAG. 112 | | | |

